

galcoholsters.com



Galco Customer Service can be reached
Toll Free at 800-874-2526
or by Email at:
customerservice@galcoholsters.com

IMPORTANT SAFETY WARNINGS AND INSTRUCTIONS READ PRIOR TO USING GALCO PRODUCTS

⚠ DANGER

Firearms users must understand and obey the Rules of Firearm Safety:

1. **Treat all firearms as if they are always loaded.**
2. **Never point a firearm at anything you aren't willing to shoot.**
3. **Keep your finger off the trigger until you intend to shoot.**
4. **Be sure of your target and what is behind/beyond it.**

Read and understand all owner's manuals, instructions, and guides prepared by the manufacturer of your firearm prior to use. If you have any questions about correct fit, contact Galco Customer Service at **800-874-2526** or customerservice@galcoholsters.com. You may also visit us at galcoholsters.com where you can use our online fitting guide.

⚠ WARNING Carrying a firearm with an ill-fitting or improper holster can result in serious injury or death. The purchase and use of a Galco holster is at the sole and exclusive risk of the user.

READ AND UNDERSTAND THIS ENTIRE GUIDE PRIOR TO USING THIS PRODUCT

Firearms are inherently dangerous. Improper or careless use of a firearm or firearm and holster may result in serious injury or death. It is the user's responsibility to possess a thorough knowledge of, and be properly trained in, all aspects of firearm use, including holster use and safety.

Carry the firearm in the safe condition recommended by its manufacturer. This information will be contained in the product information manual provided by the firearm manufacturer. If you do not have the manual applicable to the firearm, contact the firearm's manufacturer.

It is the user's responsibility to maintain the holster by regularly checking component parts for excessive wear and proper function.

⚠ WARNING Failure to heed these warnings or follow the operating instructions may result in negligent discharge of a firearm, causing serious injury or death.

⚠ WARNING Do not in any way modify, disassemble or remove any part from this holster, except as approved and recommended in Galco's Product Information Guide.

Always place your hand on the firearm when you are performing other physically vigorous activities.

Checking tension units each time the holster is used is required as part of your regular safety inspection. Applying a small amount of clear nail polish to the threads of the tension units, after proper adjustment, will help minimize screw loosening.

⚠ WARNING Tension units are not pre-set at the factory. If a holster has tension units, it is the user's responsibility to ensure they are adjusted to retain the firearm.

⚠ CAUTION Always protect an exposed magazine release from accidental activation.

⚠ WARNING When drawing a firearm or engaging it with the holster, **DO NOT** place your finger on the trigger, in the trigger guard, or near the trigger. Position your finger along the frame of the firearm above the trigger guard. Keep your finger off the trigger until your sights are on target. 

⚠ WARNING If the firearm is not properly secured by means of friction from the holsters molding or of the retention device(s), it could become dislodged, causing injury and possibly death to the user and others.

⚠ WARNING A firearm (whether in or out of a holster) may discharge if it falls to the ground or onto another object, causing death or serious injury. Holsters are not designed or intended to prevent firearms from discharging when dropped.

⚠ WARNING A holster is not a replacement for a safe. Firearms should be secured in a locked safe when not in use. Firearms should not be stored in holsters for long periods, even when in a safe. The holster may trap moisture against the firearm and promote corrosion.

⚠ WARNING A significant number of negligent discharges - some resulting in injury or death - occur while holstering a firearm. Most are caused by the user's index finger pressing the trigger. Some are caused because a foreign object becomes entangled or trapped in the trigger guard/holster and presses the trigger. The safest practice is to "look the firearm into the holster". This should be done methodically and without rushing. While holstering, be fully cognizant that:

1. All safeties are engaged.
2. Your index finger is straight along the firearm's frame. **DO NOT** place your finger on the trigger, in the trigger guard, or near the trigger. Keep your finger off the trigger until your sights are on the target.
3. No articles of clothing (shirt tails, jacket drawstrings, etc.) become trapped in the trigger guard, holster, or between the firearm and holster.
4. Your shooting-hand thumb is placed over the hammer or the rear of the slide. This will enable you to feel if the hammer starts to move rearward or the slide begins to come out of battery.
5. You strictly observe Rule of Firearms Safety #2: never point a firearm at anything you aren't willing to shoot. If you do not know how to holster your firearm without breaking this rule, you should seek training before holstering your firearm while the holster is worn.

6. If for any reason you are unable to "look the firearm into the holster" and not muzzle yourself or others, you should remove the holster from your body, then "look the firearm into the holster" (without breaking Rule #2). After the firearm is securely seated in the holster, attach the holster to your body/clothing in the manner in which it was designed.

7. If you holster your firearm while the holster is off and in your hand, insure you do **NOT** point the firearm at your support hand. Do not place your support hand (or other body parts) at the bottom of the holster. The holster material is not bullet proof. Neither your support hand, other body parts, nor other people should be muzzled/flagged while holstering. 

CARRY CONDITION OF THE FIREARM

⚠ WARNING Some single-action revolvers and some semi-automatic pistols must be carried with the hammer or firing pin resting on an empty chamber.

Carrying any firearm with a live cartridge in the chamber immediately in front of the firing pin may cause a negligent discharge. Information regarding the safe carry condition of your firearm will be contained in the product information manual provided by the firearm's manufacturer. If you are unsure of the safe carry condition(s) of your firearm, contact the firearm's manufacturer.

⚠ WARNING Never holster a firearm in the single-action mode, unless it is a semi-automatic pistol and holster designed and intended for "cocked and locked" or "Condition One" carry. Always ensure that a single-action pistol carried in "Condition One" has the manual safety engaged when carrying in a holster.

⚠ WARNING Do not use customized, modified, worn or broken firearms, or those otherwise outside the original manufacturer's specifications, with a Galco holster.

⚠ WARNING Do not place a loaded firearm in a holster without first testing - with a firearm double-checked and verified to be unloaded - for proper firearm fit.

⚠ CAUTION Do not attempt to cock a holstered firearm as this may damage the firearm, the holster, or both and may contribute to a negligent discharge.

IF ANY DOUBT EXISTS AS TO THE SERVICEABILITY OR SAFETY OF A GALCO PRODUCT, IMMEDIATELY CEASE USING IT!

If you have questions, contact: Galco Customer
Service at **800-874-2526** or
customerservice@galcoholsters.com

Galco has made every effort to properly label all holsters for the specific firearms they fit. However, firearms manufacturers often make changes to their firearms that affect holster fit.

Galco will not be responsible for such changes, nor for typographical or other human errors that may occur. It is the user's responsibility to ensure proper holster fit with actual firearms.

It is important to understand that all products, including firearms, holsters and slings may eventually "wear out" or become unsuitable for the function for which they were designed. Stress and strain placed on a product will vary according to frequency and conditions of use, and therefore it is difficult to indicate a recommended replacement date for this product.

DO

NOTICE Full grain leather holsters that come in contact with bodily perspiration, the elements, or become soiled on a regular basis may need to be treated periodically to slow the natural breakdown of the leather fibers. Dry the leather naturally, without any type of artificial heat.

Clean synthetic material as needed by hand using a soft bristle brush. If additional cleaning is needed, wash by hand with a mild soap and water. Allow to air dry naturally.

DON'T

NOTICE Do not put Galco synthetic or leather products in the washing machine. Do not use any solvents of corrosive chemicals on this product.

Do not use artificial heat to speed up the drying process, i.e. from a hair-dryer, oven, radiator, direct sunlight, etc. Do not leave Galco products on the dashboard of your car in summertime. Do not leave Galco products exposed to direct sunlight or excessive heat for long periods of time.

Do not use LocTite® or threadlock. Outgassing from these adhesive compounds will adversely affect plastic, nylon and rubber parts.

The above care and maintenance instructions cannot substitute for your good common sense. Following our recommended care and maintenance tips will allow you to get the maximum service life from all of your Galco products.

⚠ WARNING Galco holsters are approved for use with multiple firearms. Care must always be taken to ensure your holster is an appropriate and approved fit for your firearm.

REPAIRS

Great care was taken to select the finest materials available to craft your Galco product. It was designed in accordance with the highest engineering standards and hand made using traditional leather craft practices that have become Galco hallmarks over five decades. In the unlikely event a repair is necessary to an unaltered Galco product, simply contact our Customer Service department at **800-874-2526** or customerservice@galcoholsters.com. We will issue you a Return Authorization (RA) number to print on the outside of your shipping container and provide you with detailed shipping instructions.

GALCO
HOLSTERS

PRODUCT INFORMATION GUIDE UNDERWRAPS 2.0 & UNDERWRAPS ELITE BELLY BAND

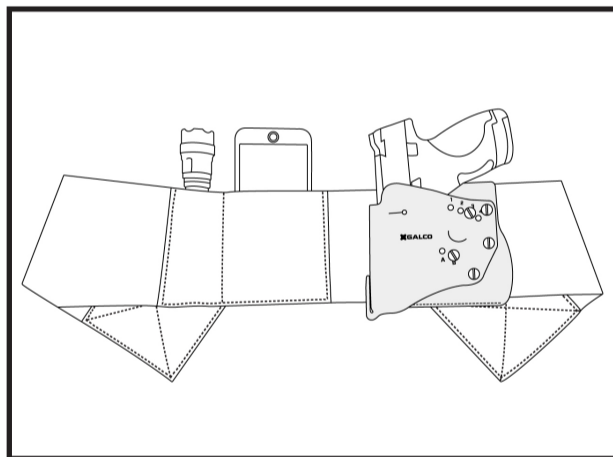

galcoholsters.com

2019 W Quail Avenue Phoenix, AZ 85027

SAFETY SYMBOL DEFINITIONS

⚠ DANGER

Indicates a hazardous situation which, if not avoided, will result in death or serious injury.

⚠ WARNING

Indicates a hazardous situation which, if not avoided, will result in death or serious injury.

⚠ CAUTION

Indicates a hazardous situation which, if not avoided, will result in minor or moderate injury.

NOTICE

Used to address practices unrelated to potential personal injury.



Visit galcoholsters.com/videos to view related safety videos.

THANK YOU FOR YOUR PURCHASE - WE APPRECIATE IT!

The UnderWraps™ 2.0 and UnderWraps Elite™ quite possibly pack more options than any other holster design on the market today!

Galco's update of the traditional bellyband allows concealed carry of multiple weapons and accessories around your midsection, in an infinite variety of configurations. Both can be worn like a traditional belly band (low on the waistline, partially under the belt line or just above it), or it can be worn around the torso's mid-section (around the solar plexus area).

Both UnderWraps designs also accommodate right or left hand draw, strongside, crossdraw, appendix, and kidney carry.

UNDERWRAPS 2.0 BELLY BAND

The UnderWraps 2.0 enables you to make instant additions and changes to your rig. Two leather holsters facilitate stable positioning of one of two firearms simultaneously, while two accessory pockets accommodate badge, cuffs, ammo – you name it!

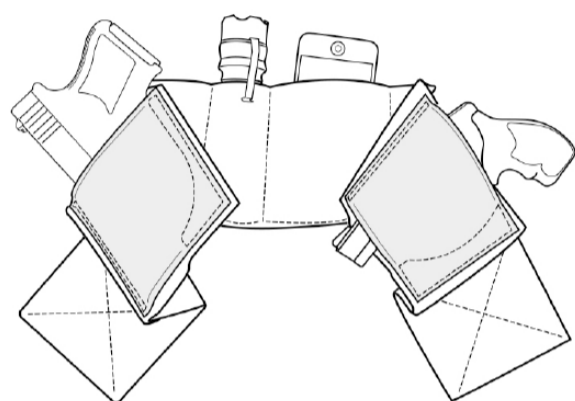

Two holsters, multiple pockets.

UNDERWRAPS ELITE BELLY BAND

The UnderWraps Elite™ takes versatility and gun fit one step further by adding adjustability to the holster component. The single holster assembly can be positioned anywhere on the elasticized nylon band, while the holster component can be adjusted for a custom fit to a wide variety of defensive handguns. The holster component may be adjusted for right or left hand draw, and neutral/vertical or butt-forward cant.

Like the UnderWraps 2.0, the Elite has pockets for spare ammo, flashlight, cuffs, badge or other EDC items.

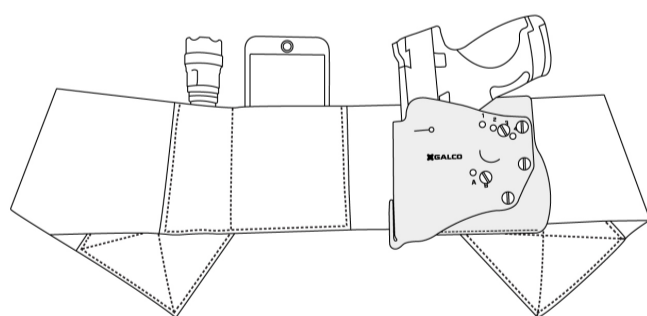

One holster, multiple pockets.

HOW TO WEAR

The UnderWraps 2.0 and UnderWraps Elite can be worn like a traditional bellyband (low on your waistline, partially under your belt line or just above it), or it can be worn around your torso mid-section (around the solar plexus area). Making the two gun pockets of leather extends the service life of the holsters, and stabilizes your firearms in the precise position and angle you prefer. Two elastic utility pockets add even more possibilities.

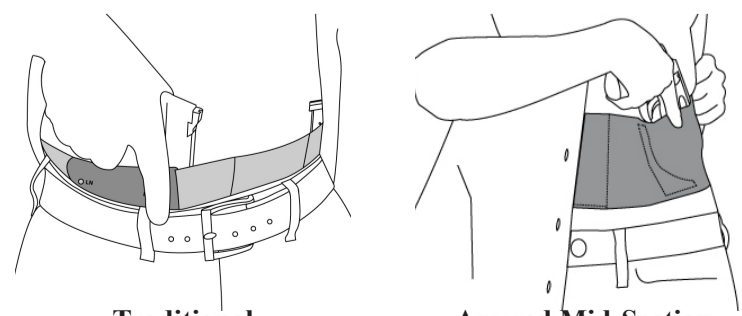

Traditional

Around Mid-Section

RIGHT/LEFT HAND USE

On the UnderWraps 2.0, the right-handed user should wear the leather pockets against the body, while the left-handed user should wear them facing outward.

The UnderWraps Elite comes from the factory set up for right-hand carry in the neutral cant position. Left-handed users should convert the holster assembly for left-hand use. Right and left-handed users may adjust the cant from neutral to butt-forward to suit their preference. Procedures for conversion and adjustment follow.

Both units should be worn so the holstered handgun(s) are in the desired location(s) on the body, with the utility pocket location being secondary. Both right and left handed users should wear the holsters against the body, with the band over the holsters on the outside.

ATTACHING THE ELITE HOLSTER ASSEMBLY TO THE BAND

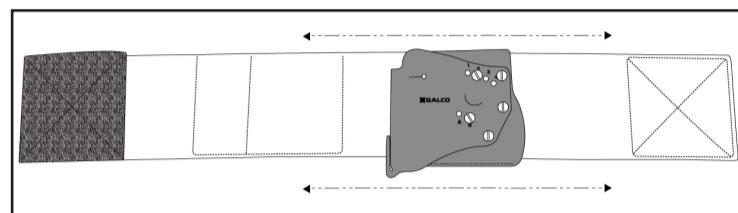

The holster assembly on the UnderWraps Elite slides along the band so the user may determine the perfect location of the holster for him/her. The assembly must also be removed to convert the holster from right to left-hand use.

PRO TIP: Cup band end to get holster started on band.

PRO TIP: All writing on holster backing plate and holster body should be upright when slid onto band and when worn.

WARNING UNLOAD YOUR FIREARM (chamber, magazine, cylinder) before testing holster fit.

ADJUSTING FOR CANT/ANGLE

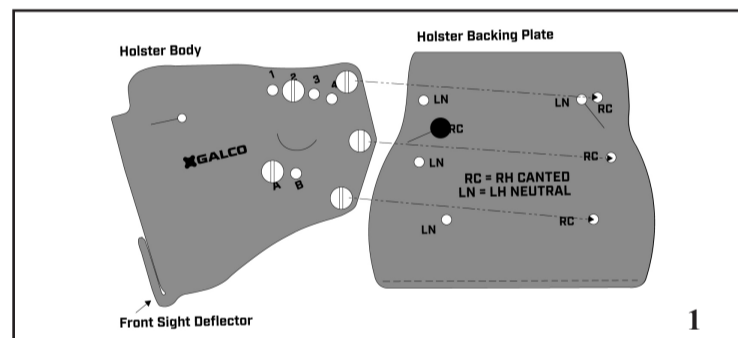

To adjust the cant of the UnderWraps Elite holster component, slide the holster assembly off the band. Separate the holster body from the holster backing plate by removing the three attachment screws (fig. 1) and detaching the polymer keyhole fastener. Use the marked guideholes (fig. 2) on the holster backing plate to reattach the holster body in either neutral cant (marked RN or LN) or canted (marked RC or LC). Slide the holster assembly back onto the band so that the holster pocket will lay against your body when worn, with the openings of the utility band pockets pointing up.

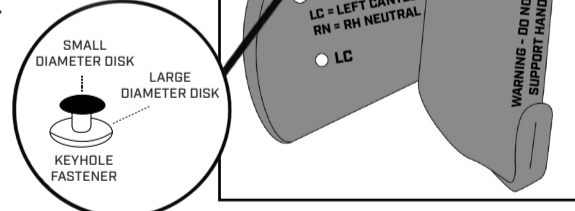

ADJUSTING THE WELT FOR YOUR GUN

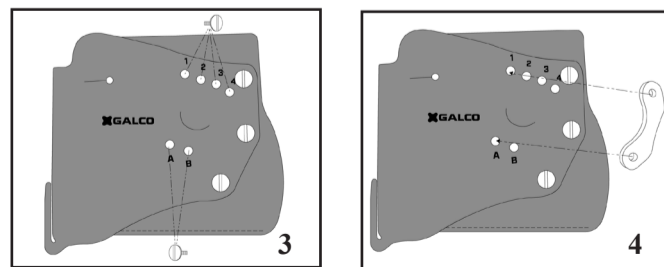

The holster body can be adjusted to fit a wide variety of defensive handguns using the adjustable welt and two screw/post assemblies. Use the numbered and lettered holes corresponding to the lists below to select the correct fit for your firearm. (figs. 3 & 4) The holster body need not be removed from the sliding backer to adjust.

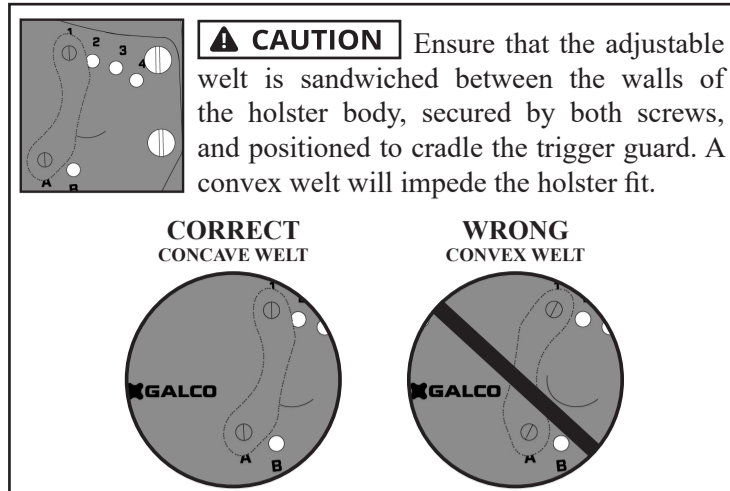

WELT SETTINGS FOR SPECIFIC HANDGUNS



Diamondback DB380/DB9, Colt Mustang, Keltec P32/P3AT, Kimber Micro 9, Remington RM380, Ruger LCPI/II, SIG-Sauer P938, Walther PPK and similar

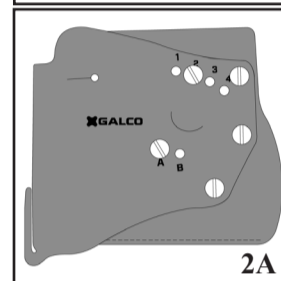

Bersa BP9, Glock 42/43/43X/48, Kahr 45, Kimber Solo, Ruger LC9, SIG-Sauer P365/P365 XL and similar

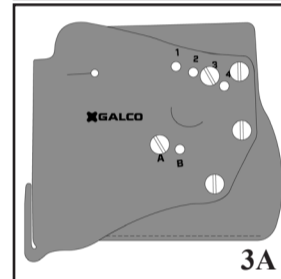

Glock 17/19/26, Honor Defense Honor Guard, S&W J-Frame, S&W Shield series, Ruger Security-9 series and similar

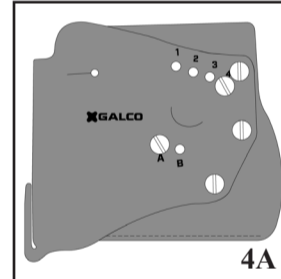

Charter Arms Bulldog/Undercover, Colt Cobra/Detective Special, Ruger LCR/SP101, S&W J-Frame Scandium, Taurus 85/605 and similar

WELT SETTINGS FOR SPECIFIC HANDGUNS (continued)

SIG-Sauer P230/P232 and similar

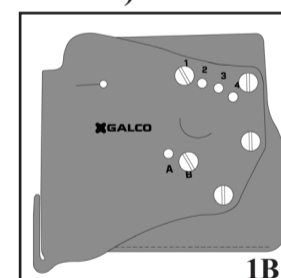

3"-5" 1911's

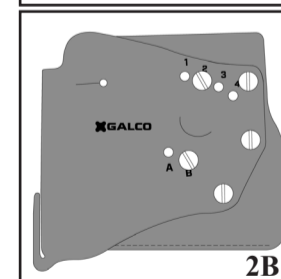

Glock 20/21/29/30, SIG-Sauer P220/P226/P229/P239, HK P2000/VP9 series, Hi-Point C9, S&W M&P series, Springfield XD-S 3.3", Taurus P111/PT140/PT145/G2C/G2S/Millennium Pro, Walther PPS and similar

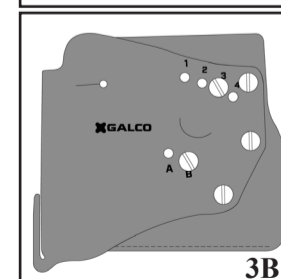

SIG-Sauer P320 series

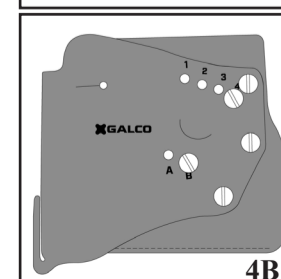

WARNING Care must always be taken to ensure your holster is an appropriate and approved fit for your firearm and adjusted according to the above guidelines. Never carry a firearm in any holster not specifically recommended by Galco for that firearm. For a complete list of gun fits, visit galcoholsters.com.

CONVERTING TO LEFT HAND USE

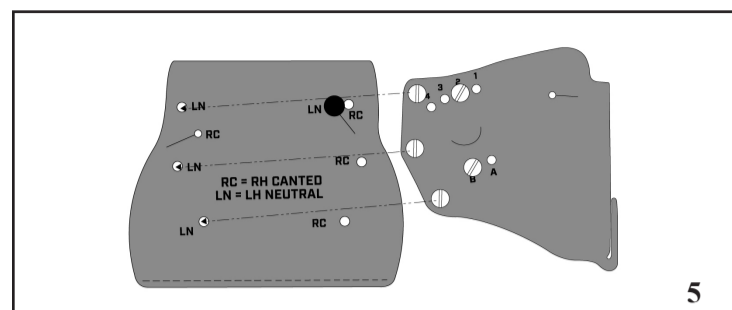

To convert the UnderWraps Elite holster assembly from right to left-hand use, slide the holster assembly off the waistband. Separate the holster component from the sliding backer by removing the three attachment screws and detaching the polymer keyhole fastener. Use the marked guideholes on the sliding backer to reattach (fig. 5) the holster component in either left-hand neutral cant (marked LN) or left-hand canted (marked LC). Slide the holster assembly back onto the waistband so that the holster component will lay against your body, with the openings of the utility pockets up.

PRO TIP: Cup band end to get holster started on band.

PRO TIP: All writing on holster backing plate and holster body should be upright when slid onto band and when worn.

TERMS OF SALE

Because we have no control over the use of our products, all Galco products are sold as is and "with all faults". The entire risk as to the quality and performance of the product is with the buyer. Should the product prove defective following its purchase, the buyer and not the manufacturer, distributor, or retailer assumes the entire risk of all the necessary servicing or repairs. Under no circumstances shall Galco be liable for incidental or consequential damages, such as loss of use of property, commercial loss and loss of earnings or profits. The implied warranties of merchantability and fitness for a particular purpose and all other warranties, expressed or implied, are excluded from this transaction and shall not apply to the product sold. The determination of the fitness or the suitability of any product for a specific use is the responsibility of the buyer. The illustrations shown here are typical as to the finish and application. Due to uncontrollable variances in color saturation, the actual product may differ slightly from that shown on our web site. Galco reserves the right to make changes in product built and/or sold by them at any time without incurring any obligation to make same or similar changes on products previously manufactured and/or sold by them. All Galco products are made in the U.S.A. and produced according to rigid specifications. Prices and models are subject to change without notice. Some states do not allow the exclusion or limitation of implied warranties or liability for incidental or consequential damages, so the above limitations and exclusions may not apply to you. Galco designs, features, and model names are the exclusive property of Galco International. Any and all persons including, but not limited to, individuals, firms and/or corporations are forbidden from imitating, copying or reproducing them in any way.